

# GX SERIES

**Related Information**

- General terms and conditions..... F-3
- Selection guide ..... P.781~
- Glossary of terms..... P.1576~
- General precautions ..... P.1579~

- FIBER SENSORS
- LASER SENSORS
- PHOTOELECTRIC SENSORS
- MICRO PHOTOELECTRIC SENSORS
- AREA SENSORS
- SAFETY LIGHT CURTAINS / SAFETY COMPONENTS
- PRESSURE / FLOW SENSORS
- INDUCTIVE PROXIMITY SENSORS**
- PARTICULAR USE SENSORS
- SENSOR OPTIONS
- SIMPLE WIRE-SAVING UNITS
- WIRE-SAVING SYSTEMS
- MEASUREMENT SENSORS
- STATIC CONTROL DEVICES
- LASER MARKERS
- PLC
- HUMAN MACHINE INTERFACES
- ENERGY MANAGEMENT SOLUTIONS
- FA COMPONENTS
- MACHINE VISION SYSTEMS
- UV CURING SYSTEMS

Selection Guide
Amplifier Built-in
Amplifier-separated
Other Products

GX-F/H
GXL
GL
GX-M
GX-U/GX-FU/GX-N
<b>GX</b>



[panasonic.net/id/pidsx/global](http://panasonic.net/id/pidsx/global)



## Robust enclosure and bending-resistant cable types are also available

### VARIETIES

#### Miniature

**GX-3S**

The **GX-3S** is an amplifier built-in inductive proximity sensor having a diameter of just  $\phi 3.8$  mm  $\phi 0.150$  in.



#### Robust housing

**GX-4S**

The **GX-4S** uses a robust stainless steel enclosure. The tightening torque can be 0.58 N·m or less. (2 times compared with conventional models)

Tightening torque: **0.58 N·m or less**

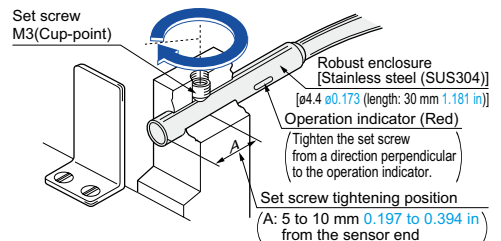

### BASIC PERFORMANCE

#### Long sensing range

**GX-8ML**

The non-shielded type (**GX-8ML**) has twice the sensing range of the shielded type (**GX-8M**), although having the same size. Hence, it allows margin against sensing distance variations.

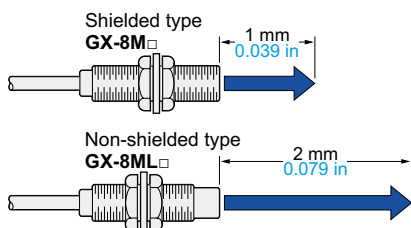

### ENVIRONMENTAL RESISTANCE

#### Ten times greater bending durability (Compared with conventional models)

**GX-□-R**

The bending durability of the cable to repeated bending has been increased tenfold by using special alloy cores for the cable.

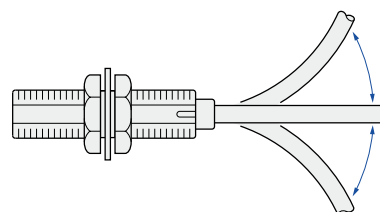

**APPLICATIONS**

**Sensing screws on cassette**

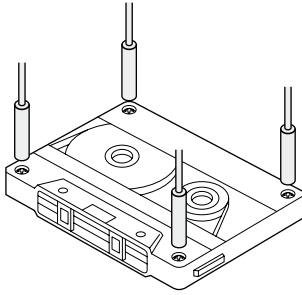

**Sensing the punch of a die**

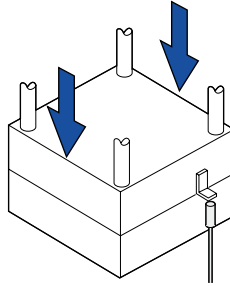

**Counting parts**

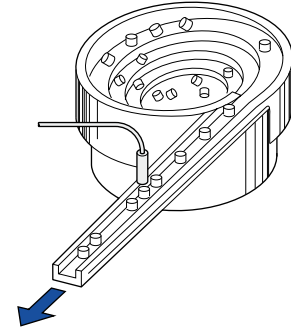

FIBER SENSORS

LASER SENSORS

PHOTO-ELECTRIC SENSORS

MICRO PHOTO-ELECTRIC SENSORS

AREA SENSORS

SAFETY LIGHT CURTAINS/ SAFETY COMPONENTS

PRESSURE/ FLOW SENSORS

**INDUCTIVE PROXIMITY SENSORS**

PARTICULAR USE SENSORS

SENSOR OPTIONS

SIMPLE WIRE-SAVING UNITS

WIRE-SAVING SYSTEMS

MEASUREMENT SENSORS

STATIC CONTROL DEVICES

LASER MARKERS

PLC

HUMAN MACHINE INTERFACES

ENERGY MANAGEMENT SOLUTIONS

FA COMPONENTS

MACHINE VISION SYSTEMS

UV CURING SYSTEMS

Selection Guide

Amplifier Built-in

Amplifier-separated

Other Products

**GX-F/H**

**GXL**

**GL**

**GX-M**

GX-U/GX-FU/

GX-N

**GX**

**ORDER GUIDE**

Type	Appearance (mm in)	Sensing range (Note)	Model No.	Supply voltage	Output	Output operation	
Shielded type		Maximum operation distance 0.8 mm 0.031 in (0 to 0.6 mm 0 to 0.024 in) Stable sensing range	GX-3S	12 to 24 V DC ±10 %	NPN open-collector transistor	Normally open	
			GX-3SB			Normally closed	
		0.8 mm 0.031 in (0 to 0.6 mm 0 to 0.024 in)	GX-4S			Normally open	
			GX-4SB			Normally closed	
		1 mm 0.039 in (0 to 0.8 mm 0 to 0.031 in)	GX-5S			10 to 30 V DC	Normally open
			GX-5SB			Normally closed	
Non-shielded type		0.8 mm 0.031 in (0 to 0.6 mm 0 to 0.024 in)	GX-5M	12 to 24 V DC ±10 %	Normally open		
			GX-5MB		Normally closed		
		1 mm 0.039 in (0 to 0.8 mm 0 to 0.031 in)	GX-8M	10 to 30 V DC	Normally open		
			GX-8MB		Normally closed		
	2 mm 0.079 in (0 to 1.6 mm 0 to 0.063 in)	GX-8ML	Normally open				
		GX-8MLB	Normally closed				

Note: The maximum operation distance stands for the maximum distance for which the sensor can detect the standard sensing object. The stable sensing range stands for the sensing range for which the sensor can stably detect the standard sensing object even if there is an ambient temperature drift and/or supply voltage fluctuation.

- FIBER SENSORS
- LASER SENSORS
- PHOTO-ELECTRIC SENSORS
- MICRO PHOTO-ELECTRIC SENSORS
- AREA SENSORS
- SAFETY LIGHT CURTAINS/ SAFETY COMPONENTS
- PRESSURE / FLOW SENSORS
- INDUCTIVE PROXIMITY SENSORS
- PARTICULAR USE SENSORS
- SENSOR OPTIONS
- WIRE-SAVING UNITS
- WIRE-SAVING SYSTEMS
- MEASUREMENT SENSORS
- STATIC CONTROL DEVICES
- LASER MARKERS
- PLC
- HUMAN MACHINE INTERFACES
- ENERGY MANAGEMENT SOLUTIONS
- FA COMPONENTS
- MACHINE VISION SYSTEMS
- UV CURING SYSTEMS

## ORDER GUIDE

### Bending-resistant cable type

Bending-resistant cable type is also available for shielded type. When ordering this type, suffix “-R” to the model No. (e.g.) Bending-resistant cable type of **GX-3S** is “**GX-3S-R**”.

### 5 m 16.404 ft cable length type

5 m 16.404 ft cable length type (standard: 3 m 9.843 ft) is also available. (excluding **GX-4SB**) When ordering this type, suffix “-C5” to the model No. (e.g.) 5 m 16.404 ft cable length type of **GX-3S** is “**GX-3S-C5**”.

Refer to table below for 5 m 16.404 ft cable length type of bending-resistant cable type sensor.

• Table of model Nos.

Type		Standard	Bending-resistant cable of 5 m 16.404 ft cable length type
Shielded type	Non-threaded type	<b>GX-3S</b>	<b>GX-3S-R-C5</b>
		<b>GX-3SB</b>	<b>GX-3SB-R-C5</b>
		<b>GX-4S</b>	<b>GX-4S-R-C5</b>
		<b>GX-4SB</b>	—
		<b>GX-5S</b>	<b>GX-5S-R-C5</b>
	Threaded type	<b>GX-5SB</b>	—
		<b>GX-5M</b>	<b>GX-5M-R-C5</b>
		<b>GX-5MB</b>	—
		<b>GX-8M</b>	<b>GX-8M-R-C5</b>
		<b>GX-8MB</b>	<b>GX-8MB-R-C5</b>

### Accessories

- **MS-SS3** (Sensor mounting bracket for **GX-3S** type)
- **MS-SS3-2** (C bracket for **GX-3S** type)
- **MS-SS5** (Sensor mounting bracket for **GX-5S** type)

- **MS-SS3**
- **MS-SS5**

- **MS-SS3-2**

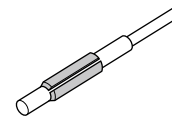
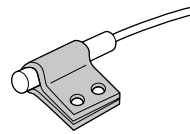

By using the C bracket, the applicable tightening force can be doubled.

- Selection Guide
- Amplifier Built-in
- Amplifier-separated
- Other Products
- GX-F/H**
- GXL**
- GL**
- GX-M**
- GX-U/GX-FU/ GX-N
- GX**

**SPECIFICATIONS****Non-threaded type**

Item	Type Model No.	Shielded type											
		Bending-resistant cable				Bending-resistant cable				Bending-resistant cable			
		GX-3S	GX-3SB	GX-3S-R	GX-3SB-R	GX-4S	GX-4SB	GX-4S-R	GX-4SB-R	GX-5S	GX-5SB	GX-5S-R	GX-5SB-R
CE marking directive compliance		EMC Directive, RoHS Directive											
Max. operation distance (Note 2)		0.8 mm <b>0.031 in</b> ±15 %						1 mm <b>0.039 in</b> ±15 %					
Stable sensing range (Note 2)		0 to 0.6 mm <b>0 to 0.024 in</b>						0 to 0.8 mm <b>0 to 0.031 in</b>					
Standard sensing object		Iron sheet 5 × 5 × t 1 mm <b>0.197 × 0.197 × t 0.039 in</b>						Iron sheet 6 × 6 × t 1 mm <b>0.236 × 0.236 × t 0.039 in</b>					
Hysteresis		15 % or less of operation distance (with standard sensing object)											
Repeatability		20 μm <b>0.787 mil</b> or less						8 μm <b>0.315 mil</b> or less					
Supply voltage		12 to 24 V DC ±10 % Ripple P-P 10 % or less						10 to 30 V DC Ripple P-P 10 % or less					
Current consumption		15 mA or less											
Output		NPN open-collector transistor <ul style="list-style-type: none"> <li>Maximum sink current: 50 mA</li> <li>Applied voltage: 30 V DC or less (between output and 0 V)</li> <li>Residual voltage: 0.4 V or less (at 50 mA sink current)</li> </ul>						NPN open-collector transistor <ul style="list-style-type: none"> <li>Maximum sink current: 200 mA (Note 3)</li> <li>Applied voltage: 30 V DC or less (between output and 0 V)</li> <li>Residual voltage: 1.5 V or less (at 200 mA sink current) 0.4 V or less (at 50 mA sink current)</li> </ul>					
	Utilization category	DC-12 or DC-13											
	Output operation	Normally open	Normally closed	Normally open	Normally closed	Normally open	Normally closed	Normally open	Normally closed	Normally open	Normally closed	Normally open	Normally closed
Short-circuit protection	—						Incorporated						
Max. response frequency		1 kHz						1.5 kHz					
Operation indicator		Red LED (lights up when the output is ON)											
Environmental resistance	Pollution degree	3 (Industrial environment)											
	Protection	IP67 (IEC)											
	Ambient temperature	-25 to +70 °C <b>-13 to +158 °F</b> , Storage: -25 to +80 °C <b>-13 to +176 °F</b>											
	Ambient humidity	35 to 95 % RH, Storage: 35 to 95 % RH						35 to 85 % RH, Storage: 35 to 95 % RH					
	Voltage withstandability	500 V AC for one min. between all supply terminals connected together and enclosure											
	Insulation resistance	5 MΩ, or more, with 250 V DC megger between all supply terminals connected together and enclosure						50 MΩ, or more, with 500 V DC megger between all supply terminals connected together and enclosure					
	Vibration resistance	10 to 55 Hz frequency, 1.5 mm <b>0.059 in</b> double amplitude in X, Y and Z directions for two hours each											
Shock resistance	200 m/s <sup>2</sup> acceleration (20 G approx.) in X, Y and Z directions ten times each						300 m/s <sup>2</sup> acceleration (30 G approx.) in X, Y and Z directions ten times each						
	—						—						
Sensing range variation	Temperature characteristics	Over ambient temperature range -25 to +70 °C <b>-13 to +158 °F</b> : Within ±20 % of sensing range at +20 °C <b>+68 °F</b>						Over ambient temperature range -25 to +70 °C <b>-13 to +158 °F</b> : Within ±15 % of sensing range at +20 °C <b>+68 °F</b>					
	Voltage characteristics	Within ±2 % for ±10 % fluctuation of the supply voltage						Within ±2.5 % for ±15 % fluctuation of the supply voltage					
Material		Enclosure: Stainless steel (SUS304), Resin part: TPX						Enclosure: Brass (Nickel plated) Resin part: ABS					
Cable		0.08 mm <sup>2</sup> 3-core oil, heat and cold resistant cabtyre cable, 3 m <b>9.843 ft</b> long	0.1 mm <sup>2</sup> 3-core bending, oil and heat resistant cabtyre cable, 3 m <b>9.843 ft</b> long	0.08 mm <sup>2</sup> 3-core oil, heat and cold resistant cabtyre cable, 3 m <b>9.843 ft</b> long	0.1 mm <sup>2</sup> 3-core bending, oil and heat resistant cabtyre cable, 3 m <b>9.843 ft</b> long	0.14 mm <sup>2</sup> 3-core oil, heat and cold resistant cabtyre cable, 3 m <b>9.843 ft</b> long	0.15 mm <sup>2</sup> 3-core bending, oil and heat resistant cabtyre cable, 3 m <b>9.843 ft</b> long						
Cable extension		Extension up to total 100 m <b>328.084 ft</b> is possible with 0.3 mm <sup>2</sup> , or more, cable.											
Weight		Net weight: 30 g approx.						Net weight: 55 g approx.					
Accessories		<b>MS-SS3</b> (Sensor mounting bracket): 1 pc. <b>MS-SS3-2</b> (C bracket): 1 pc.						<b>MS-SS5</b> (Sensor mounting bracket): 1 pc.					

Notes: 1) Where measurement conditions have not been specified precisely, the conditions used were an ambient temperature of +23 °C **+73.4 °F**.

2) The maximum operation distance stands for the maximum distance for which the sensor can detect the standard sensing object.

The stable sensing range stands for the sensing range for which the sensor can stably detect the standard sensing object even if there is an ambient temperature drift and/or supply voltage fluctuation.

3) The maximum sink current varies depending on the ambient temperature. Refer to "I/O CIRCUIT AND WIRING DIAGRAMS (p.846)" for details.

FIBER SENSORS

LASER SENSORS

PHOTO-ELECTRIC SENSORS

MICRO PHOTO-ELECTRIC SENSORS

AREA SENSORS

SAFETY LIGHT CURTAINS / SAFETY COMPONENTS

PRESSURE / FLOW SENSORS

INDUCTIVE PROXIMITY SENSORS

PARTICULAR USE SENSORS

SENSOR OPTIONS

SIMPLE WIRE-SAVING UNITS

WIRE-SAVING SYSTEMS

MEASUREMENT SENSORS

STATIC CONTROL DEVICES

LASER MARKERS

PLC

HUMAN MACHINE INTERFACES

ENERGY MANAGEMENT SOLUTIONS

FA COMPONENTS

MACHINE VISION SYSTEMS

UV CURING SYSTEMS

Selection Guide

Amplifier Built-in

Amplifier-separated

Other Products

**GX-F/H****GXL****GL****GX-M**

GX-U/GX-FU/GX-N

**GX**

**SPECIFICATIONS****Threaded type**

Type	Shielded type								Non-shielded type			
	Bending-resistant cable				Bending-resistant cable							
Item	Model No.	GX-5M	GX-5MB	GX-5M-R	GX-5MB-R	GX-8M	GX-8MB	GX-8M-R	GX-8MB-R	GX-8ML	GX-8MLB	
CE marking directive compliance	EMC Directive, RoHS Directive											
Max. operation distance (Note 2)	0.8 mm <b>0.031 in</b> ±15 %					1 mm <b>0.039 in</b> ±15 %				2 mm <b>0.079 in</b> ±15 %		
Stable sensing range (Note 2)	0 to 0.6 mm <b>0 to 0.024 in</b>					0 to 0.8 mm <b>0 to 0.031 in</b>				0 to 1.6 mm <b>0 to 0.063 in</b>		
Standard sensing object	Iron sheet 5 × 5 × t 1 mm <b>0.197 × 0.197 × t 0.039 in</b>					Iron sheet 8 × 8 × t 1 mm <b>0.315 × 0.315 × t 0.039 in</b>				Iron sheet 12 × 12 × t 1 mm <b>0.472 × 0.472 × t 0.039 in</b>		
Hysteresis	15 % or less of operation distance (with standard sensing object)					10 % or less of operation distance (with standard sensing object)						
Repeatability	20 μm <b>0.787 mil</b> or less					8 μm <b>0.315 mil</b> or less				40 μm <b>1.575 mil</b> or less		
Supply voltage	12 to 24 V DC ±10 % Ripple P-P 10 % or less					10 to 30 V DC Ripple P-P 10 % or less						
Current consumption	15 mA or less											
Output	NPN open-collector transistor <ul style="list-style-type: none"> <li>Maximum sink current: 50 mA</li> <li>Applied voltage: 30 V DC or less (between output and 0V)</li> <li>Residual voltage: 0.4 V or less (at 50 mA sink current)</li> </ul>					NPN open-collector transistor <ul style="list-style-type: none"> <li>Maximum sink current: 200 mA (Note 3)</li> <li>Applied voltage: 30 V DC or less (between output and 0 V)</li> <li>Residual voltage: 1.5 V or less (at 200 mA sink current) 0.4 V or less (at 50 mA sink current)</li> </ul>						
	Utilization category	DC-12 or DC-13										
	Output operation	Normally open	Normally closed	Normally open	Normally closed	Normally open	Normally closed	Normally open	Normally closed	Normally open	Normally closed	
	Short-circuit protection	—					Incorporated					
Max. response frequency	1 kHz					500 Hz						
Operation indicator	Red LED (lights up when the output is ON)											
Environmental resistance	Pollution degree	3 (Industrial environment)										
	Protection	IP67 (IEC)										
	Ambient temperature	– 25 to +70 °C <b>–13 to +158 °F</b> , Storage: – 25 to +80 °C <b>– 13 to +176 °F</b>										
	Ambient humidity	35 to 95 % RH, Storage: 35 to 95 % RH					35 to 85 % RH, Storage: 35 to 95 % RH					
	Voltage withstandability	500 V AC for one min. between all supply terminals connected together and enclosure										
	Insulation resistance	5 MΩ, or more, with 250 V DC megger between all supply terminals connected together and enclosure					50 MΩ, or more, with 500 V DC megger between all supply terminals connected together and enclosure					
	Vibration resistance	10 to 55 Hz frequency, 1.5 mm <b>0.059 in</b> double amplitude in X, Y and Z directions for two hours each										
Shock resistance	200 m/s <sup>2</sup> acceleration (20 G approx.) in X, Y and Z directions ten times each					300 m/s <sup>2</sup> acceleration (30 G approx.) in X, Y and Z directions ten times each				300 m/s <sup>2</sup> acceleration (30 G approx.) in X, Y and Z directions three times each		
Sensing range variation	Temperature characteristics	Over ambient temperature range – 25 to +70 °C <b>–13 to +158 °F</b> : Within ±20 % of sensing range at +20 °C <b>+68 °F</b>					Over ambient temperature range – 25 to +70 °C <b>–13 to +158 °F</b> : Within $\pm\frac{15}{-10}$ % of sensing range at +20 °C <b>+68 °F</b>					
	Voltage characteristics	Within ±2 % for ±10 % fluctuation of the supply voltage					Within ±2.5 % for ±15 % fluctuation of the supply voltage					
Material	Enclosure: Brass (Nickel plated) Resin part: TPX					Enclosure: Brass (Nickel plated) Resin part: ABS						
Cable	0.08 mm <sup>2</sup> 3-core oil, heat and cold resistant cabtyre cable, 3 m <b>9.843 ft</b> long		0.1 mm <sup>2</sup> 3-core bending, oil and heat resistant cabtyre cable, 3 m <b>9.843 ft</b> long		0.14 mm <sup>2</sup> 3-core oil, heat and cold resistant cabtyre cable, 3 m <b>9.843 ft</b> long		0.15 mm <sup>2</sup> 3-core bending, oil and heat resistant cabtyre cable, 3 m <b>9.843 ft</b> long		0.14 mm <sup>2</sup> 3-core, oil, heat and cold resistant cabtyre cable, 3 m <b>9.843 ft</b> long			
Cable extension	Extension up to total 100 m <b>328.084 ft</b> is possible with 0.3 mm <sup>2</sup> , or more, cable.									Extension up to total 100 m <b>328.084 ft</b> is possible with 0.14 mm <sup>2</sup> , or more, cable.		
Weight (Note 4)	Net weight: 30 g approx.					Net weight: 60 g approx.						
Accessories	Nut: 2 pcs. Toothed lock washer: 1 pc.		Nut: 2 pcs. Toothed lock washer: 2 pcs.		Nut: 2 pcs. Toothed lock washer: 1 pc.		Nut: 2 pcs. Toothed lock washer: 2 pcs.		Nut: 2 pcs. Toothed lock washer: 1 pc.			

Notes: 1) Where measurement conditions have not been specified precisely, the conditions used were an ambient temperature of +23 °C **+73.4 °F**.

2) The maximum operation distance stands for the maximum distance for which the sensor can detect the standard sensing object.

The stable sensing range stands for the sensing range for which the sensor can stably detect the standard sensing object even if there is an ambient temperature drift and/or supply voltage fluctuation.

3) The maximum sink current varies depending on the ambient temperature. Refer to **"I/O CIRCUIT AND WIRING DIAGRAMS (p.846)"** for details.

4) The given weight of the threaded type includes the weight of nuts and toothed lock washers.

**I/O CIRCUIT AND WIRING DIAGRAMS**

**GX-5S□ GX-8M□ GX-8ML□**

**I/O circuit diagram**

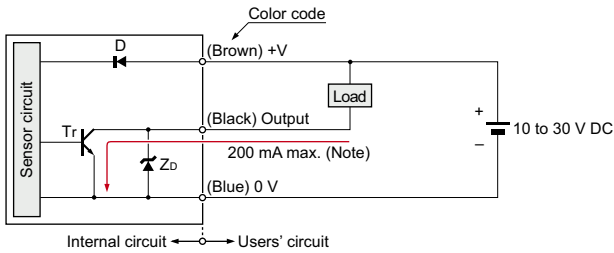

Symbols ... D : Reverse supply polarity protection diode  
 Zd: Surge absorption zener diode  
 Tr : NPN output transistor

- If a capacitor of 1  $\mu\text{F}$  or more is connected between 0 V and output or between +V and output, connect a 100  $\Omega$  resistor in series as shown below.

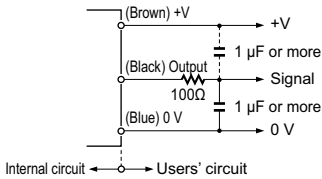

Without the resistor, the short-circuit protection is activated by the charge or discharge current of the capacitor, so that it results in delaying the response whenever the sensor switches. The connected resistor solves this problem.

**Wiring diagram**

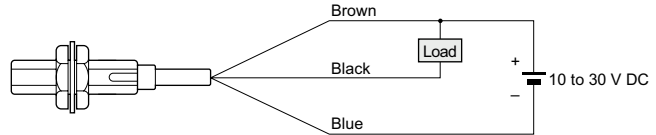

Note: The maximum sink current varies depending on the ambient temperature.

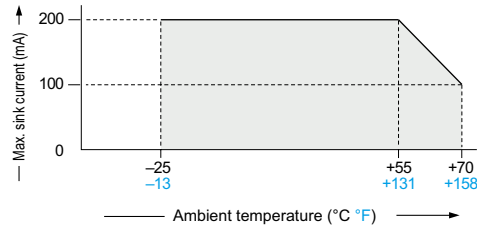

**GX-3S□ GX-4S□ GX-5M□**

**I/O circuit diagram**

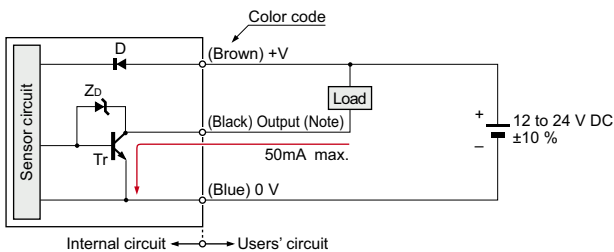

Note: **GX-3S□, GX-4S□ and GX-5M□** do not incorporate a short-circuit protection circuit at the output. Do not connect them directly to a power supply or a capacitive load.

Symbols ... D : Reverse supply polarity protection diode  
 Zd: Surge absorption zener diode  
 Tr : NPN output transistor

**Wiring diagram**

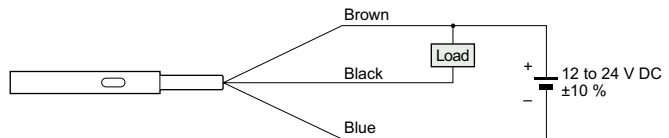

FIBER SENSORS

LASER SENSORS

PHOTO-ELECTRIC SENSORS

MICRO PHOTO-ELECTRIC SENSORS

AREA SENSORS

SAFETY LIGHT CURTAINS / SAFETY COMPONENTS

PRESSURE / FLOW SENSORS

INDUCTIVE PROXIMITY SENSORS

PARTICULAR USE SENSORS

SENSOR OPTIONS

SIMPLE WIRE-SAVING UNITS

WIRE-SAVING SYSTEMS

MEASUREMENT SENSORS

STATIC CONTROL DEVICES

LASER MARKERS

PLC

HUMAN MACHINE INTERFACES

ENERGY MANAGEMENT SOLUTIONS

FA COMPONENTS

MACHINE VISION SYSTEMS

UV CURING SYSTEMS

Select Guide

Amplifier Built-in

Amplifier-separated

Other Products

**GX-F/H**

**GXL**

**GL**

**GX-M**

GX-U/GX-FU/  
GX-N

**GX**

**SENSING CHARACTERISTICS (TYPICAL)**

- FIBER SENSORS
- LASER SENSORS
- PHOTO-ELECTRIC SENSORS
- MICRO PHOTO-ELECTRIC SENSORS
- AREA SENSORS
- SAFETY LIGHT CURTAINS/ SAFETY COMPONENTS
- PRESSURE/ FLOW SENSORS
- INDUCTIVE PROXIMITY SENSORS**
- PARTICULAR USE SENSORS
- SENSOR OPTIONS
- SIMPLE WIRE-SAVING UNITS
- WIRE-SAVING SYSTEMS
- MEASUREMENT SENSORS
- STATIC CONTROL DEVICES
- LASER MARKERS
- PLC
- HUMAN MACHINE INTERFACES
- ENERGY MANAGEMENT SOLUTIONS
- FA COMPONENTS
- MACHINE VISION SYSTEMS
- UV CURING SYSTEMS
- Selection Guide
- Amplifier Built-in
- Amplifier-separated
- Other Products
- GX-F/H
- GXL
- GL
- GX-M**
- GX-U/GX-FU
- GX-N
- GX**

**GX-3S □ GX-4S □ GX-5M □**

**Sensing field**

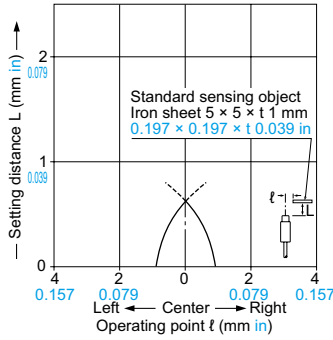

**Correlation between sensing object size and sensing range**

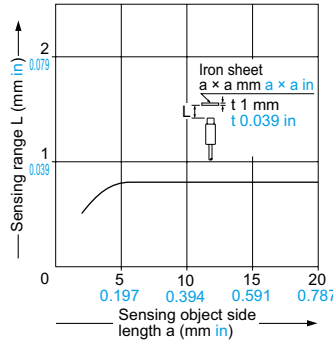

As the sensing object size becomes smaller than the standard size (iron sheet 5 × 5 × t 1 mm 0.197 × 0.197 × t 0.039 in), the sensing range shortens as shown in the left figure.

**GX-5S □**

**Sensing field**

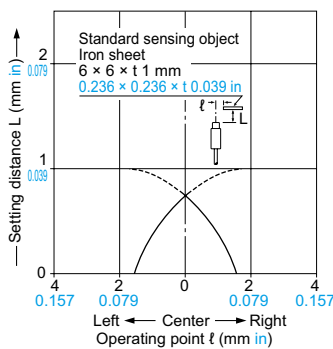

**Correlation between sensing object size and sensing range**

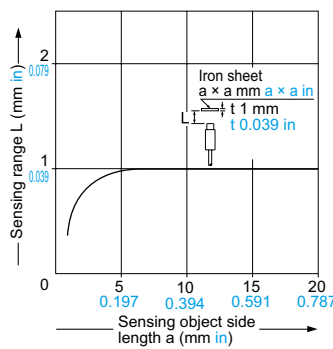

As the sensing object size becomes smaller than the standard size (iron sheet 6 × 6 × t 1 mm 0.236 × 0.236 × t 0.039 in), the sensing range shortens as shown in the left figure.

**GX-8M □**

**Sensing field**

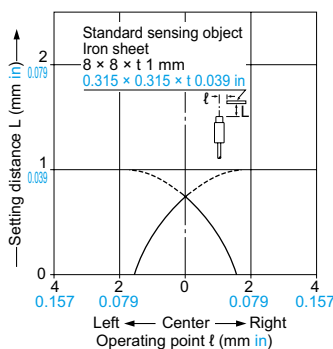

**Correlation between sensing object size and sensing range**

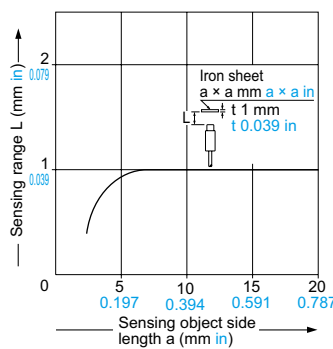

As the sensing object size becomes smaller than the standard size (iron sheet 8 × 8 × t 1 mm 0.315 × 0.315 × t 0.039 in), the sensing range shortens as shown in the left figure.

**GX-8ML □**

**Sensing field**

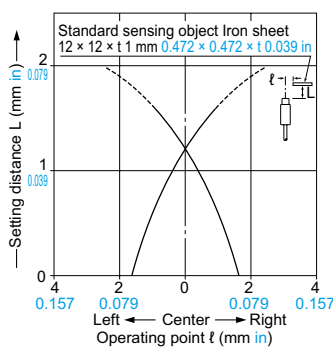

**Correlation between sensing object size and sensing range**

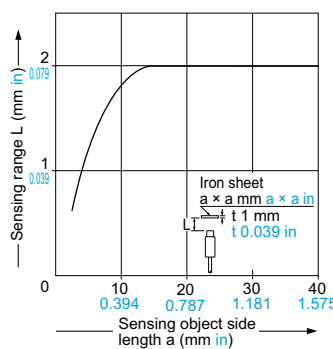

As the sensing object size becomes smaller than the standard size (iron sheet 12 × 12 × t 1 mm 0.472 × 0.472 × t 0.039 in), the sensing range shortens as shown in the left figure.

**PRECAUTIONS FOR PROPER USE**

Refer to p.1579~ for general precautions.



- Never use this product as a sensing device for personnel protection.
- In case of using sensing devices for personnel protection, use products which meet laws and standards, such as OSHA, ANSI or IEC etc., for personnel protection applicable in each region or country.

**Mounting**

- The tightening torque should be as given below.

**Mounting with set screw**

**<Shielded of threaded type>**

- Tighten the set screw on the flat surface of the sensor without applying excessive force. Make sure to use a set screw with a cup-point end.

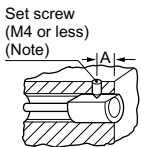

Note: To fasten **GX-5M□**, use a M3 or less set screw.

Model No.	Set screw tightening position A (mm in)	Tightening torque
<b>GX-5M□</b>	5 to 10 <b>0.197 to 0.394</b>	0.29 N·m
<b>GX-8M□</b>	8 to 22 <b>0.315 to 0.866</b>	0.29 N·m

**<Non-threaded type and non-shielded of threaded type>**

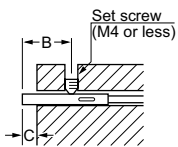

Model No.	B (mm in)	C (mm in)	Tightening torque
<b>GX-3S□</b>	5 to 10 <b>0.197 to 0.394</b>	3 <b>0.118</b>	0.29 N·m
	When using the C bracket		0.58 N·m
<b>GX-4S□</b>	5 to 10 <b>0.197 to 0.394</b>	3 <b>0.118</b>	0.58 N·m
<b>GX-5S□</b>	8 to 20 <b>0.315 to 0.787</b>	5 <b>0.197</b>	0.29 N·m
<b>GX-8ML□</b>	13 to 22 <b>0.517 to 0.866</b>	10 <b>0.394</b>	0.29 N·m

Note: The protrusion should be kept C (mm in) or more to avoid reduction of sensing range.

- To fasten **GX-3S□** and **GX-4S□**, use a M3 or less set screw and tighten it from a direction perpendicular to the operation indicator.

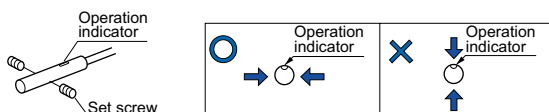

- When using the C bracket, place it on the sensor at a distance of 3 mm **0.118 in** or more from the sensor end.

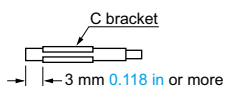

- To fasten the non-shielded threaded type, tighten the set screw on the flat surface of the sensor.

**Mounting with nut**

- Note that the maximum tightening torque differs according to the location of the nuts.

**<Shielded of threaded type>**

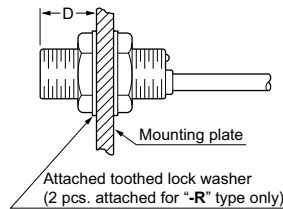

**<Non-shielded of threaded type>**

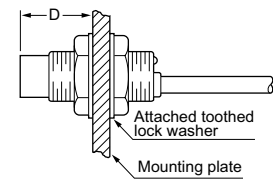

Model No.	D (mm in)	Tightening torque
<b>GX-5M□</b>	2 to 3 <b>0.079 to 0.118</b>	0.49 N·m
	3 <b>0.118</b> or more	1.47 N·m
<b>GX-8M□</b>	3 to 11 <b>0.118 to 0.433</b>	1.47 N·m
	11 <b>0.433</b> or more	3.43 N·m
<b>GX-8ML□</b>	9 to 11 <b>0.345 to 0.433</b>	0.98 N·m
	11 <b>0.433</b> or more	3.43 N·m

Note: Mount such that the nuts do not protrude from the threaded portion.

- The root truncation of the threads with **GX-8M□** and **GX-8ML□** is shallow owing to strengthening of the sensors against tightening. When tapped hole on equipment to fix the sensors, the prepared hole must be  $\varnothing 7.2$  mm  $\varnothing 0.283$  in or more.

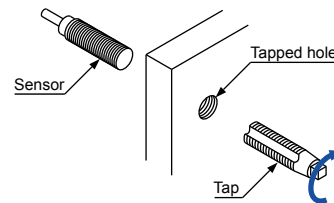

- FIBER SENSORS
- LASER SENSORS
- PHOTO-ELECTRIC SENSORS
- MICRO PHOTO-ELECTRIC SENSORS
- AREA SENSORS
- SAFETY LIGHT CURTAINS / SAFETY COMPONENTS
- PRESSURE / FLOW SENSORS
- INDUCTIVE PROXIMITY SENSORS
- PARTICULAR USE SENSORS
- SENSOR OPTIONS
- SIMPLE WIRE-SAVING UNITS
- WIRE-SAVING SYSTEMS
- MEASUREMENT SENSORS
- STATIC CONTROL DEVICES
- LASER MARKERS
- PLC
- HUMAN MACHINE INTERFACES
- ENERGY MANAGEMENT SOLUTIONS
- FA COMPONENTS
- MACHINE VISION SYSTEMS
- UV CURING SYSTEMS
- Selection Guide
- Amplifier Built-in
- Amplifier-separated
- Other Products
- GX-F/H**
- GXL**
- GL**
- GX-M**
- GX-U/GX-FU/GX-N
- GX**



- FIBER SENSORS
- LASER SENSORS
- PHOTO-ELECTRIC SENSORS
- MICRO PHOTO-ELECTRIC SENSORS
- AREA SENSORS
- SAFETY LIGHT CURTAINS / SAFETY COMPONENTS
- PRESSURE / FLOW SENSORS
- INDUCTIVE PROXIMITY SENSORS**
- PARTICULAR USE SENSORS
- SENSOR OPTIONS
- SIMPLE WIRE-SAVING UNITS
- WIRE-SAVING SYSTEMS
- MEASUREMENT SENSORS
- STATIC CONTROL DEVICES
- LASER MARKERS
- PLC
- HUMAN MACHINE INTERFACES
- ENERGY MANAGEMENT SOLUTIONS
- FA COMPONENTS
- MACHINE VISION SYSTEMS
- UV CURING SYSTEMS
- Selection Guide
- Amplifier Built-in
- Amplifier-separated
- Other Products
- GX-F/H
- GXL
- GL
- GX-M
- GX-U/GX-FU/GX-N
- GX**

## PRECAUTIONS FOR PROPER USE

Refer to p.1579~ for general precautions.

### Distance from surrounding metal

- As metal around the sensor may affect the sensing performance, pay attention to the following points.

#### Influence of surrounding metal

- The surrounding metal will affect the sensing performance. Keep the minimum distance specified in the table below.

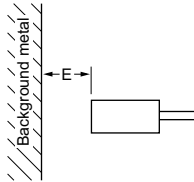

Model No.	E (mm in)
<b>GX-3S</b> □	3 <b>0.118</b>
<b>GX-4S</b> □	3 <b>0.118</b>
<b>GX-5S</b> □	4 <b>0.157</b>
<b>GX-5M</b> □	3 <b>0.118</b>
<b>GX-8M</b> □	4 <b>0.157</b>
<b>GX-8ML</b> □	8 <b>0.315</b>

#### Embedding of the sensor in metal

- Sensing range may decrease if the sensor is completely embedded in metal. Especially for the non-threaded type and the non-shielded type, keep the minimum distance specified in the table below.

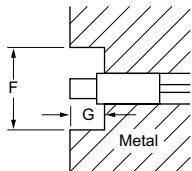

Model No.	F (mm in)	G (mm in)
<b>GX-3S</b> □	ø12 ø <b>0.472</b>	3 <b>0.118</b>
<b>GX-4S</b> □	ø12 ø <b>0.472</b>	3 <b>0.118</b>
<b>GX-5S</b> □	ø15.4 ø <b>0.606</b>	5 <b>0.197</b>
<b>GX-8ML</b> □	ø30 ø <b>1.181</b>	10 <b>0.394</b>

### Mutual interference

- When two or more sensors are installed in parallel or face to face, keep the minimum separation distance specified below to avoid mutual interference.

#### Face to face mounting

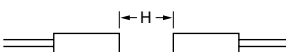

#### Parallel mounting

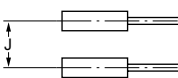

Model No.	H (mm in)	J (mm in)
<b>GX-3S</b> □	16 <b>0.630</b>	16 <b>0.630</b>
<b>GX-4S</b> □	16 <b>0.630</b>	16 <b>0.630</b>
<b>GX-5S</b> □	20 <b>0.787</b>	15 <b>0.591</b>
<b>GX-5M</b> □	10 <b>0.394</b>	10 <b>0.394</b>
<b>GX-8M</b> □	20 <b>0.787</b>	15 <b>0.591</b>
<b>GX-8ML</b> □	50 <b>1.969</b>	30 <b>1.181</b>

### Sensing range

- The sensing range is specified for the standard sensing object. With a non-ferrous metal, the sensing range is obtained by multiplying with the correction coefficient specified below. Further, the sensing range also changes if the sensing object is smaller than the standard sensing object or if the sensing object is plated.

#### Correction coefficient

Model No.	<b>GX-3S</b> □ <b>GX-4S</b> □	<b>GX-5M</b> □	<b>GX-5S</b> □ <b>GX-8M</b> □ <b>GX-8ML</b> □
Metal			
Iron	1	1	1
Stainless steel (SUS304)	0.65 approx.	0.83 approx.	0.7 approx.
Brass	0.36 approx.	0.61 approx.	0.4 approx.
Aluminum	0.30 approx.	0.58 approx.	0.35 approx.

### Others

- Do not use during the initial transient time (10 ms) after the power supply is switched on.
- Make sure that stress by forcible bend or pulling is not applied directly to the sensor cable joint.
- GX-3S**□, **GX-4S**□ and **GX-5M**□ do not incorporate a short-circuit protection circuit at the output. Do not connect them directly to a power supply or a capacitive load.

**DIMENSIONS (Unit: mm in)**

The CAD data can be downloaded from our website.

- FIBER SENSORS
- LASER SENSORS
- PHOTO-ELECTRIC SENSORS
- MICRO PHOTO-ELECTRIC SENSORS
- AREA SENSORS
- SAFETY LIGHT CURTAINS / SAFETY COMPONENTS
- PRESSURE / FLOW SENSORS
- INDUCTIVE PROXIMITY SENSORS
- PARTICULAR USE SENSORS
- SENSOR OPTIONS
- SIMPLE WIRE-SAVING UNITS
- WIRE-SAVING SYSTEMS
- MEASUREMENT SENSORS
- STATIC CONTROL DEVICES
- LASER MARKERS
- PLC
- HUMAN MACHINE INTERFACES
- ENERGY MANAGEMENT SOLUTIONS
- FA COMPONENTS
- MACHINE VISION SYSTEMS
- UV CURING SYSTEMS

**GX-3S□** Sensor

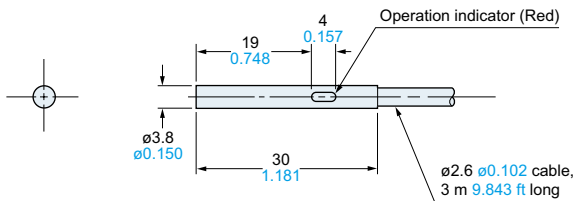

**GX-4S□** Sensor

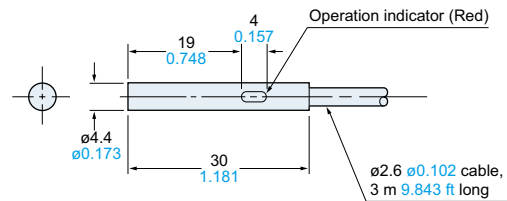

**GX-5S□** Sensor

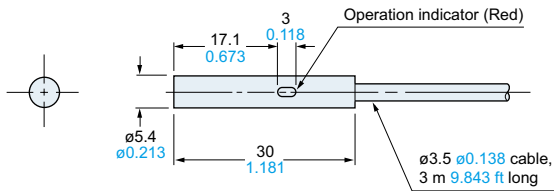

**GX-5M□** Sensor

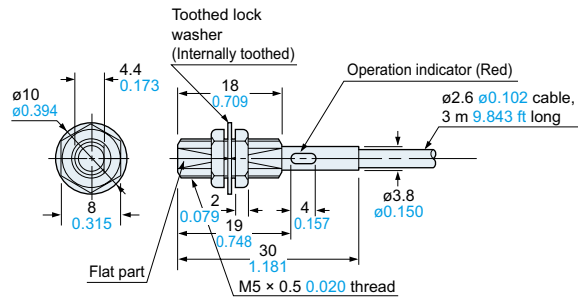

**GX-8M□** Sensor

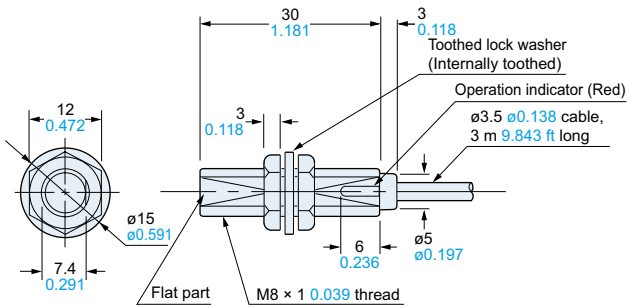

**GX-8ML□** Sensor

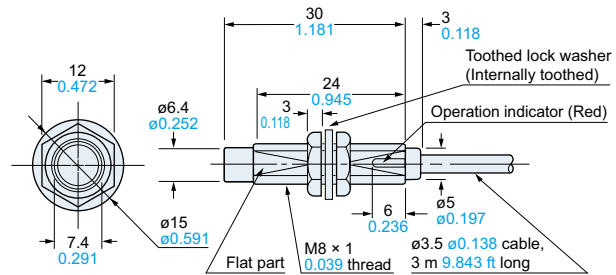

**MS-SS3-2** C bracket for GX-3S□ (Accessory for GX-3S□)

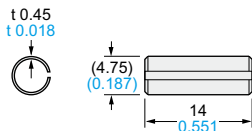

Note: By using the C bracket, the applicable tightening force can be doubled.

**MS-SS3** Sensor mounting bracket for GX-3S□ (Accessory for GX-3S□)  
**MS-SS5** Sensor mounting bracket for GX-5S□ (Accessory for GX-5S□)

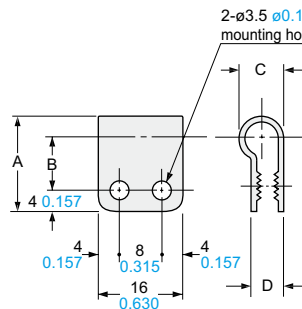

Material: Nylon 66

Model No.	MS-SS3	MS-SS5
A	16 0.630	18 0.709
B	9 0.354	10 0.394
C	6.3 0.248	8.3 0.327
D	4.9 0.193	6.1 0.240
Applicable model No.	GX-3S□	GX-5S□

- Selection Guide
- Amplifier Built-in
- Amplifier-separated
- Other Products

- GX-F/H
- GXL
- GL
- GX-M
- GX-J/GX-FU/GX-N
- GX